

A1 ROADLINES PTY LTD

R8 User Guide & Operation Manual

Mobile Digital Video Recorder



- 8 Channel 1080p/720p
- Solid State Design
- GPS Module & Internal Sensor
- Supports 4G LTE
- Anti-Vibration Technology

Notice

The information in this manual was current when published. The manufacturer reserves the right to revise and improve its products. All specifications are therefore subject to change without any notice.

The purpose of this manual is to aid the user in the the operation of the KOHLTECH MDVR. The user should have a basic understanding of computer operation and basic knowledge of how to connect peripherals.

Copyright

Under copyright laws, the content of this manual may not be copied, photocopied, reproduced, translated or reduced to any electronic medium or machine- readable form, in whole or in part, without prior written consent of A1 Roadlines

Contents

1.	PRODUCT CHARACTERISTICS.....	5
1.1.	OVERVIEW	5
1.2.	SPECIFICATIONS	5-6
1.3.	SYSTEM DIAGRAM	7
1.4.	EXTERNAL INTERFACE	7-8
1.5.	DEFINITION AND PICTURES OF EXTERNAL CABLES.....	9
2.	SETTING	10
2.1.	CONTROL PANEL.....	10
3.	OPERATING INSTRUCTIONS.....	11
3.1.	LOCAL LOGIN.....	11-12
3.2.	RECORD SEARCH AND EXPORT:.....	12-15
3.3.	LOG SEARCH AND EXPORT	15-16
3.4.	SYSTEM STATUS.....	16-18
3.5.	BASIC SETUP.....	18
3.5.1.	REGISTER INFORMATION (SETUP VEHICLE INFORMATION).....	18-19
3.5.2.	TIME SETUP	19-20
3.5.3.	START UP	20-21
3.5.4.	USER SETTING	21-22
3.5.5.	NETWORK SETTINGS.....	22-24
4.	VIDEO SURVEILLANCE	24
4.1.	REAL-TIME SURVEILLANCE.....	24-26
4.2.	RECORD	26-28
4.3.	IPC SETUP.....	28
4.4.	DATA COLLECTION	28-30
4.5.	ALARM	30-31
4.6.	MAINTENANCE	31
4.6.1.	CONFIGURATION.....	32
4.6.2.	DATA EXPORT	32
4.6.3.	UPGRADE	33
4.6.4.	STORAGE.....	33
4.6.5.	DEFAULT	34
5.	INSTALL GUIDE.....	35-38

1. Product Characteristics

1.1.Overview

KOHLTECH's R8 is Mobile Digital Video Recorder specially designed for vehicle video surveillance and remote monitoring. It has a high-speed processor and embedded operating system, combining with the most advanced H.265 video compression technology, 3G/4G support, GPS positioning technology, as well as WIFI. It supports not only video recording in 1080p, 720p, WD1, WHD1, WCIF, D1, HD1 and CIF formats, but also vehicle travel information recording and wireless data upload. With server software it also achieves alarm linkage, central monitoring, remote management and playback analysis. It is easy to use with a rugged design, superior anti-vibration, anti-electromagnetic interference, radiation protection, hard disk storage, SD backup, flexible installation and high reliability.

1.2. Specifications

Technical Items		Technical Indicators
Product Model		R8
Function Overview		Preview, Recording, Playback, Network, Locating
System	Operating System	Linux
	Control Mode	Monitor, mouse, EasyCheck, network(3G/4G/WIFI)
Video	Input	AHD*6+IPC*2
	Output	2 CH (MONITOR+VGA)
	Total Resource	PAL: 6*720P@15fps(AHD)+2*1080P@30fps(IPC) or4*1080P@10fps(AHD)+2*1080P@30fps(IPC) or4*720P@25fps(AHD)+2*1080P@30fps(IPC) NTSC : 6*720P@15fps(AHD)+2*1080P@30fps(IPC) or4*1080P@12fps(AHD)+2*1080P@30fps(IPC) or4*720P@30fps(AHD)+2*1080P@30fps(IPC)
	Video Signal Standard	Electrical level: 1Vpp Impedance: 75Ω NTSC/PAL Optional
Audio	Input	8 CH (AHD*6+IPC*2)
	Output	1 CH
	Audio Signal Standard	Electrical level: 2Vpp Input impedance: 4.7kΩ

Display	Display Split	1/4/9 Image display	
	OSD	GPS, Alarm, Vehicle plate, Speed, Time, etc.	
	Operation Interface	Semi-transparent GUI	
Recording	Video/Audio Compression	Video	H.264/H.265
		Audio	ADPCM, G.711A G.711U
	Image Resolution Note: If analog channel(AHD) 1 or channel 2 are connected to 1080P, there will be no video image for channel 5 and channel 6.	PAL: 1080P(1920X1080), 720P(1280X720), WD1(928X576), WHD1(928X288), WCIF(464X288), D1(704X576), HD1(704x288), CIF(352x288) NTSC: 1080P(1920X1080), 720P(1280X720), WD1(928X480), WHD1(928X240), WCIF(464X240), D1(704x480), HD1(704x240),CIF(352x240); Digital: 1080P(1920X1080), 720P(1280X720)	
	Image Quality	8 Levels adjustable (Level 1 is the best)	
	Recording Mode	Schedule/Alarm(sensor trigger, speed, acceleration, video loss, temperature)	
	Pre-recording	0-60min	
	Post-recording	0-30min	
Playback	Playback Channel	1/4 channel by local playback, supports WEB 1/4/8 channel by local playback	
	Search Mode	Date/time, channel, event	
Network	3G/4G	EVDO/TD-SCDMA/WCDMA/TDD-LTE/FDD-LTE optional	
	WIFI	802.11b/g/n	
	Ethernet	RJ45 x 1(10/100M)	
	IPC Ethernet	2 x 6-pin DIN JACK (10/100M PON port, power supply) 2 x 6-pin DIN JACK (10/100M Network port, no power supply)	
Locating	GPS	Location tracking, speed detection and time sync	
Sensor	G-Sensor	Built-in 6-axis inertial sensor	
Storage	HDD/SSD	1 x2.5"SATA HDD or SSD, thickness 7mm/9.5mm/15mm, supports hard disk heating	
	SD	Support SDXC 32GB/64GB/128GB/256GB, plug and play	

Interface	USB	1 x USB2.0(Type A)+ 1 x USB2.0(Type B), hot swap
	SD	1 x SD slot
	SIM	1 x SIM slot
	Serial	2 x RS232, 1 x RS485, 1 x CAN
	I/O	8 inputs, 2 outputs
	Speed	1 channel pulse speed detection
	Control Panel	Monitor
	Intercommunication	1 MIC port(Monitor)
Power	Input	DC 8~36V, ACC
	Output	5V@500mA & 12V@500mA
	Max Power Consumption	46W
	Standby Power Consumption	≈0W
Physical characteristics	Dimension(mm)	252x167.2x88.7 (with bracket and rear shield)
	Weight(KG)	2.2KG (not include HDD)
Environment	Operating Temperature	-40°C ~+70°C (with heating and no HDD)
	Operating Humidity	8%-95%(No condensation)

1.3. System Diagram

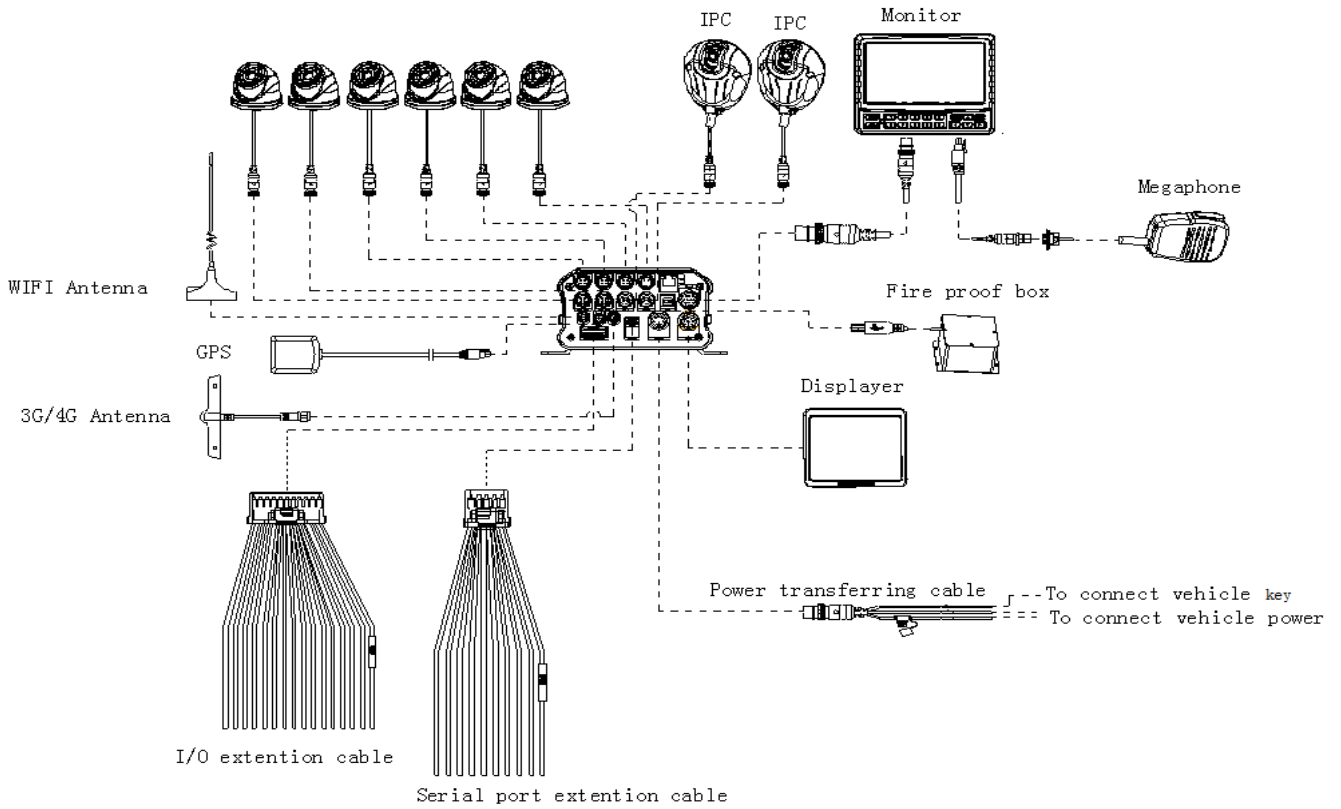

1.4. External interface

Dimension (Unit: mm)

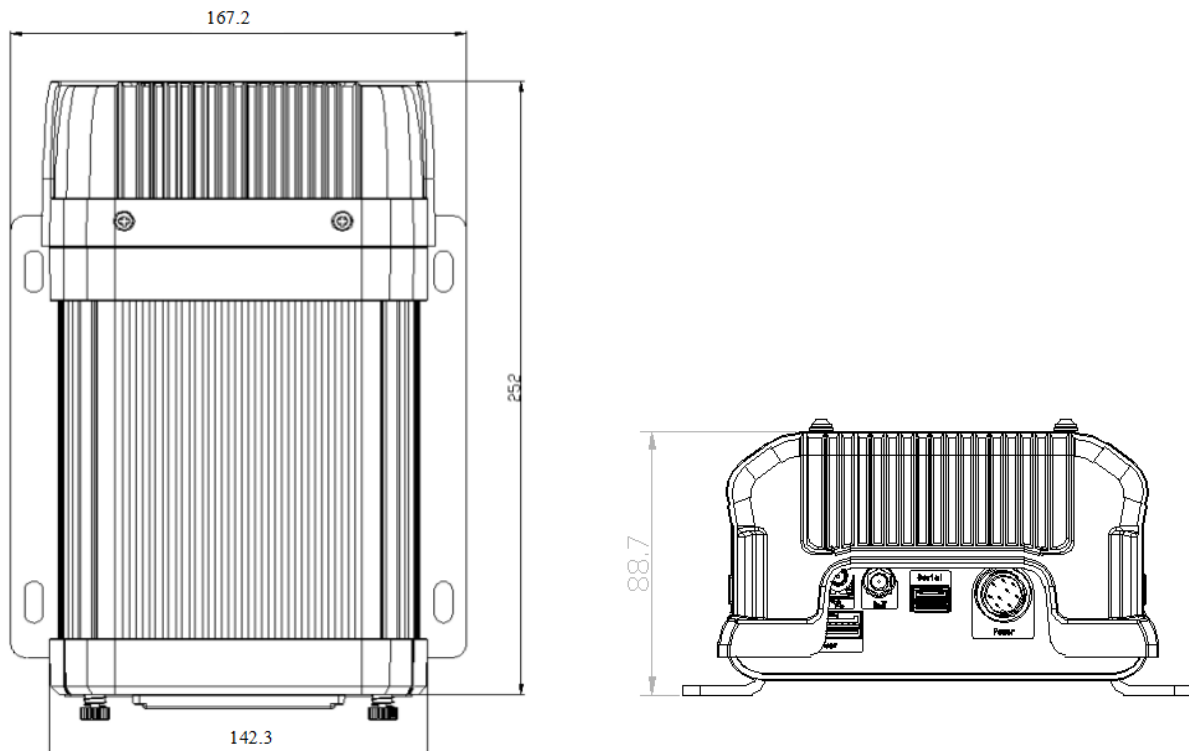

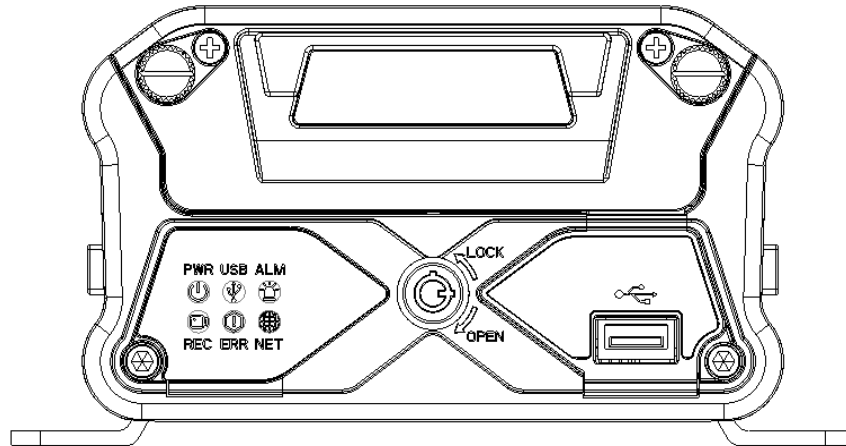

Front Panel

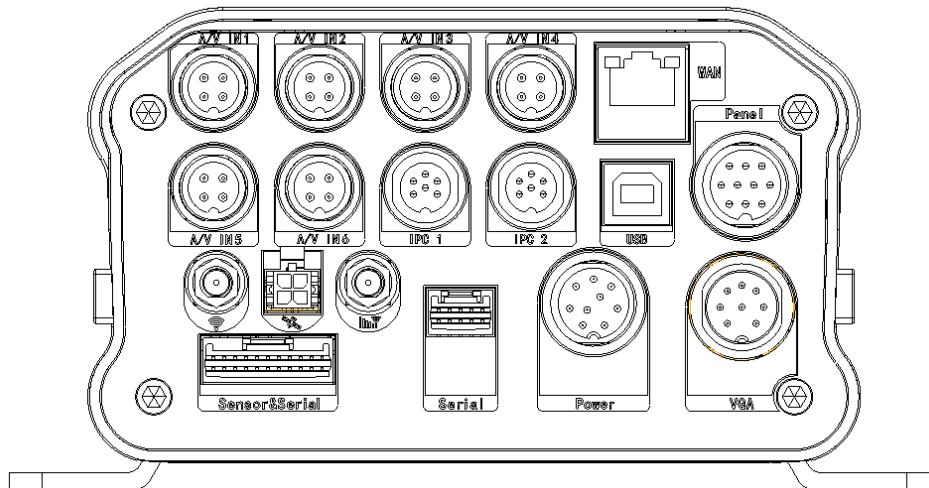

Rear Panel



Serial No.	Print	Description
1	A/V IN1~6	Analog audio/video input 1~6
2	IPC1~2	IPC A/V input 1~2
3	VGA	VGA video interface
4	WAN	100Mbps network interface
5	USB	USB 2.0 interface (Type B)
6		3G/4G antenna interface
7		GPS antenna interface
8		WIFI antenna interface
9	Sensor&Serial	Sensor & serial interface
10	Serial	Serial interface
11	Panel	Control panel interface(Monitor)
12	Power	DC8-36V power input

1.5. Hard disk installation

The procedure to install the hard disk of 9.5mm/7.5mm

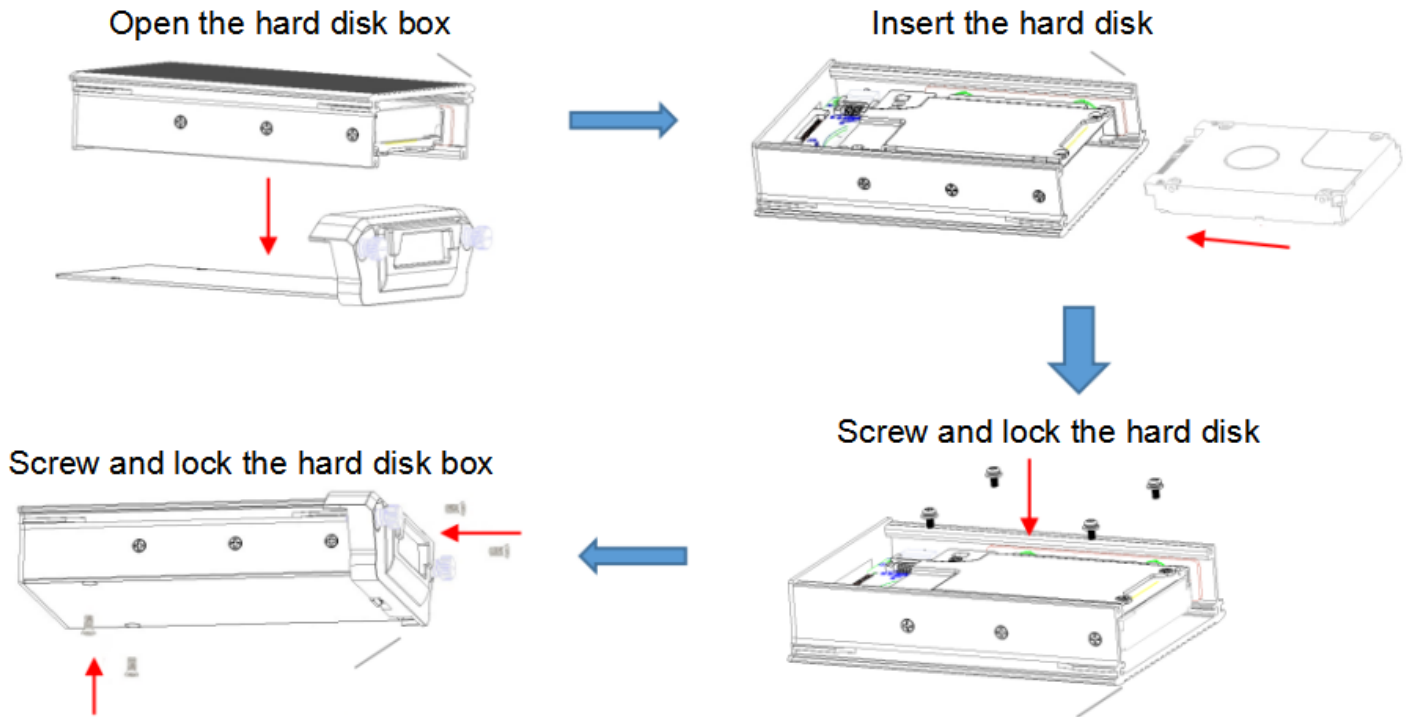

To install the hard disk of 15mm, user needs to disassemble the brackets, and then insert it.

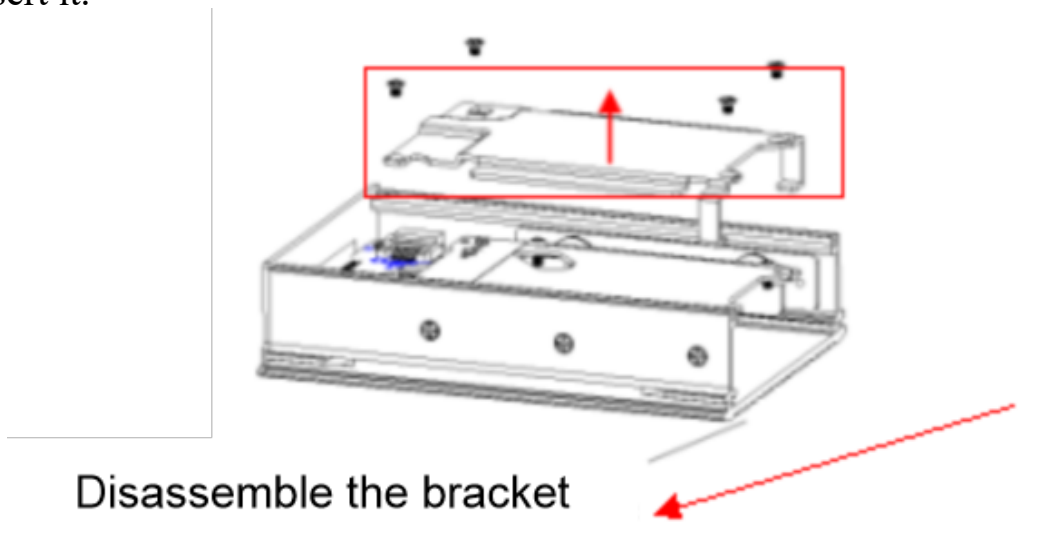

1.6. Definition and pictures of external cables

Alarm cable definition

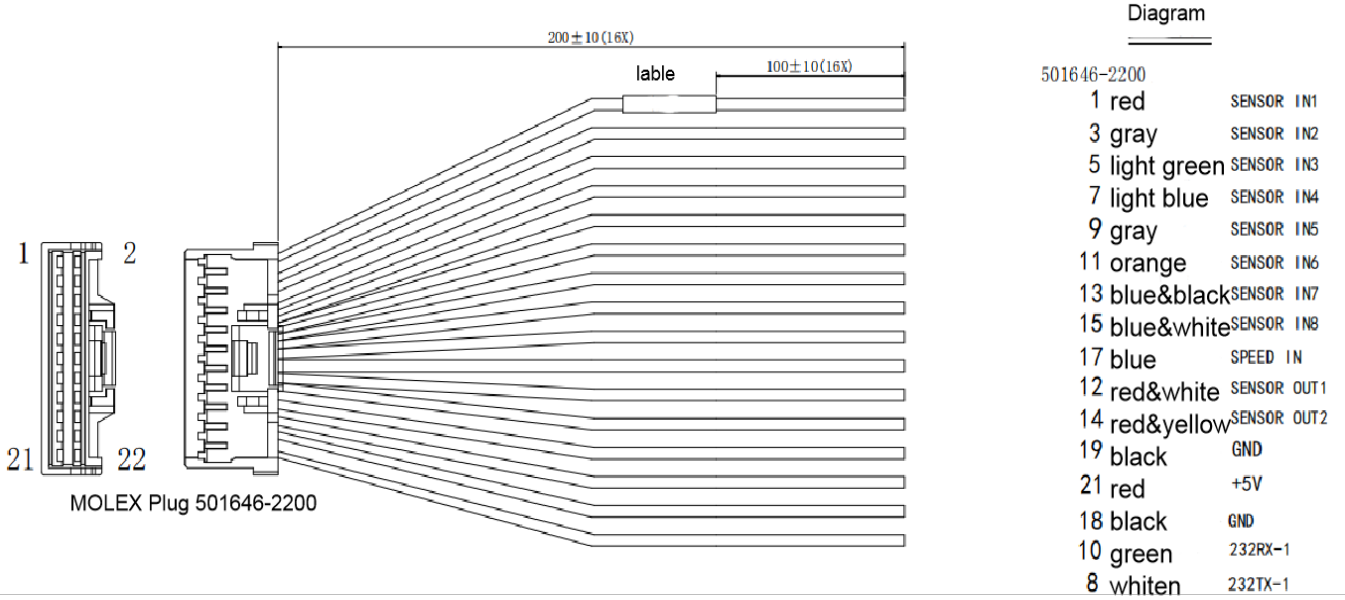

Serial port definition

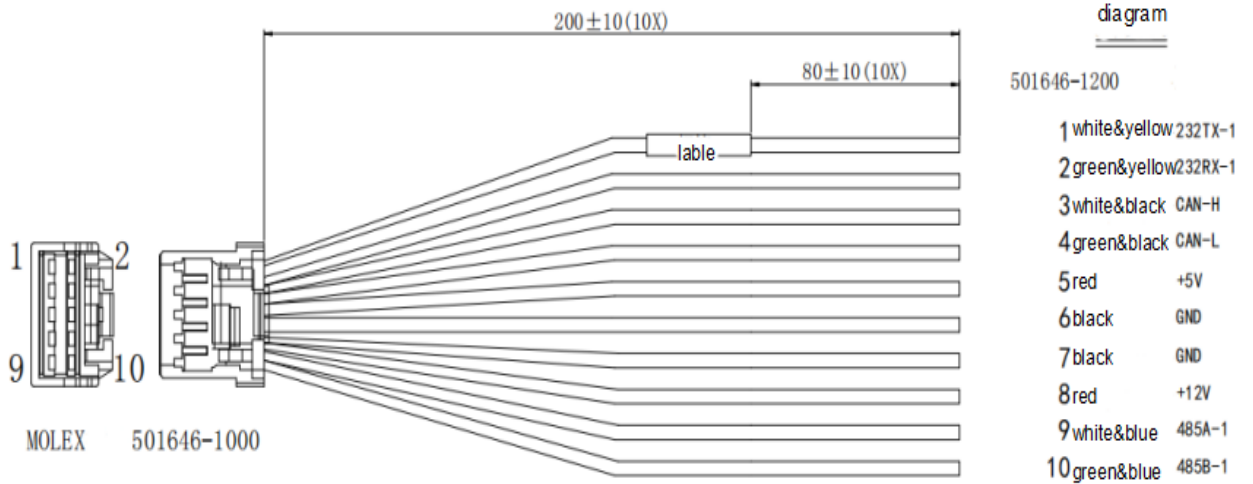

2.SETTING

2.1 CONTROL PANEL



Operation Instrument

NOTE:

When reporting to CMS server, use serial number.

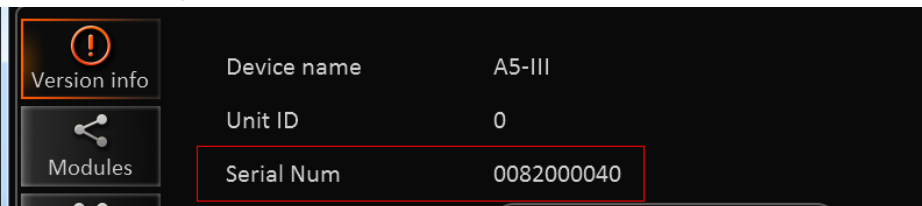

When using Android pad, you need to select vehicle number, as when insert the wifi hot spot to USB port of the 4120, the hot spot will get the vehicle number and change its SSID to vehicle number.

3. OPERATING INSTRUCTIONS

3.1. LOCAL LOGIN

- 1) Press the remote control 【LOGIN / LOCK】 or 【SETUP】 , the login screen will pop up.
- 2) Right click the mouse, the shortcut menu will pop up, left click login picture, login screen will pop up.
- 3) Left click on the login button to login and right click to log out

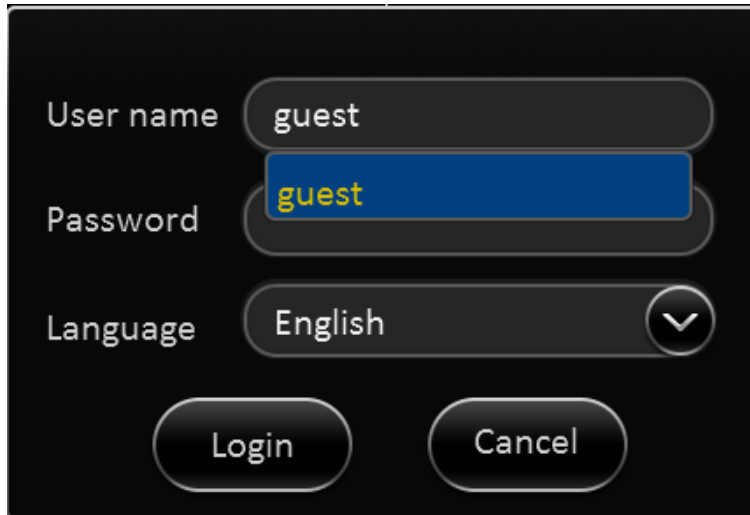

➤ **Login Notice:**

- 1) Software is automatically assigned by user name and password, it can be divided into user and administrator privileges.
- 2) Password can be disabled, when it is empty, user does not need to enter the password to login.

■ **Login interface Introduction:**

➤ **User name:**

- 1) Select users from the drop-down box. Admin and user are defaults.
- 2) Currently, it can show two users and one admin.

➤ **Password:**

- 1)

➤

- 1) **Default password and permission table is as follows::**

➤



Default Password	Related User	Related Authority
------------------	--------------	-------------------

admin	admin	All Authority
User	user	Search and playback

➤ **The password input Instruction:**

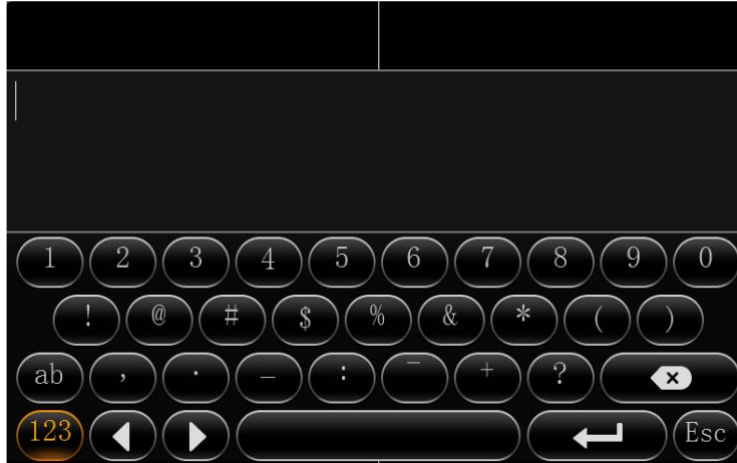
1. If the password are numbers, user can enter it on monitor keypad
2. User can click **【ENTER】** or the left click mouse on the remote control.



- a. Move the cursor to the number position, press **【Enter】** or left click mouse button to select the corresponding number.
- b. Move the cursor to **【123】**, press **【Enter】** or mouse to choose input type, such as the Numbers, letters, or special characters.
【ab】 means lower case letters, **【123】** means numbers, **【AB】** means capital letters; the highlighted place of background refers to the current cursor position.
- c. Move Cursor to , Press **【Enter】** or left click mouse to move between the contents that have entered.
- d. Move Cursor to , Press **【Enter】** or left click mouse to delete the previous input contents.
- e. Move Cursor to , Press **【Enter】** or the left click mouse to exit the keypad, the entered contents will be written to the edit box.
- f. Move Cursor to **【Esc】** position, Press **【Enter】** or the left click mouse to exit the keypad, the entered contents will not be written to the edit box

3.2. RECORD SEARCH AND EXPORT:

Video search interface contains video file search, video data backup and video playback function.

When there is a hard disk or SD card, enter the video search interface. Following is the REC Search interface:

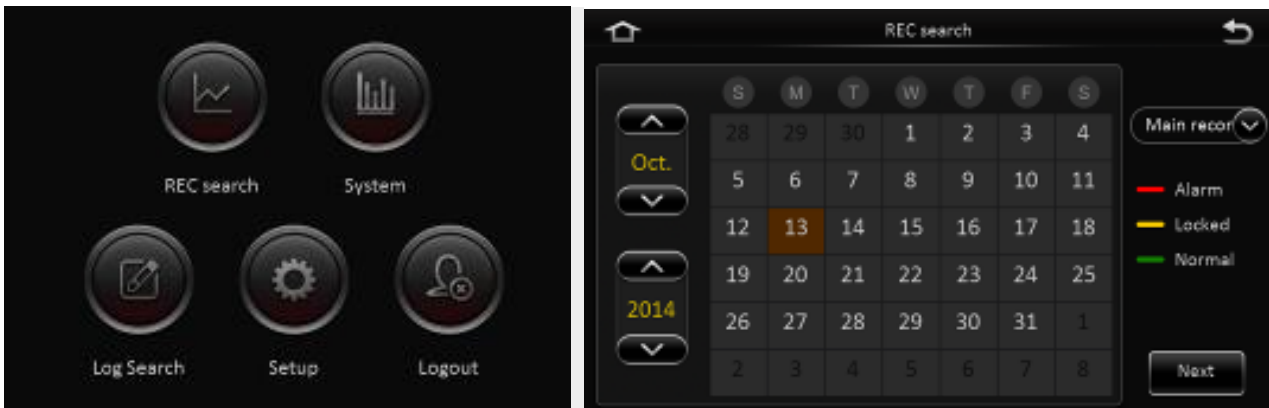

In the calendar, the color below the dates means:

- No color - no video
- Green - normal video
- Red - alarm video
- Yellow - alarms and the video files are locked.

Source: select the source of the video; Main, Sub and Mirror video. Main record means HDD record while sub record and mirror record are dual-stream records.

Select the date with record, click next, and then enter the following interface:

Following is the record search detail and record search result interface:

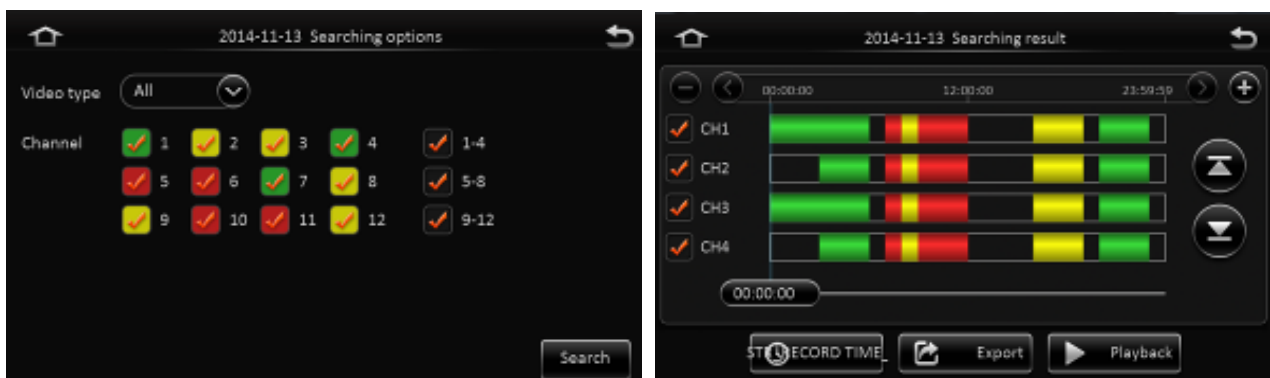

➤ Record search detail interface:

- **Record Type:** User can choose Continuous record, Alarm record or Normal record.
- **Channel selection:** The channel is optional and marked with corresponding record type. The channel with gray cannot be chosen if there is no video

➤ Click search button in the record search detail page, user can enter then record search result page.

- **Time Bar:** Time bar shows three time points, 0 o'clock, 12 o'clock, 24 o'clock. It shows what type of videos during the time according to the marked channel.
- **Channel No:** According to the situation of video for each channel video the day, the video will be displayed on the time line. Tick the channel if user wants to playback the video.

Note: channel number is displayed from 1~20, please up page up/page down button to change channel

➤ Button description

- **Video playback:** Choose the channel No., select start time to play < default start from 0 >, click the playback button to playback the video.



In playback interface, user can choose fast forward or fast rewind to play the video, the button in the middle of screen switches the channels. The image stops and it will not exit automatically when playing to the last video of the day.

- **Time period settings:** Click the time setting button, select start time and end time, it will back up or playback the video in the selected time period. Click clip to export the video, the file format can be .264 (proprietary file), or .AVI format.



- **Video export:** Select the channel that has the video files, click this button, all the video files in the effective time period will be exported to the external USB drive. File format can be .264 (proprietary format), or .avi format.

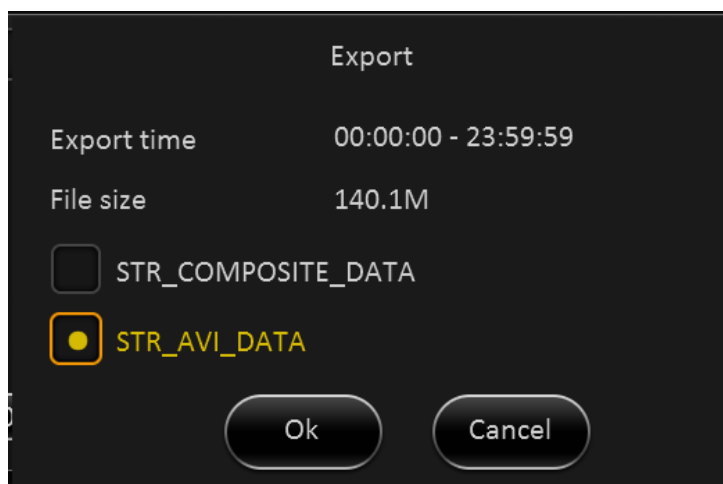

Hard drive tray or SD card can be removed to export and playback the video with Video Management Software.

3.3. LOG SEARCH AND EXPORT

In the log search interface, it records and displays all alarm events and login operation log. Enter the "log query", the interface will be shown as follows:

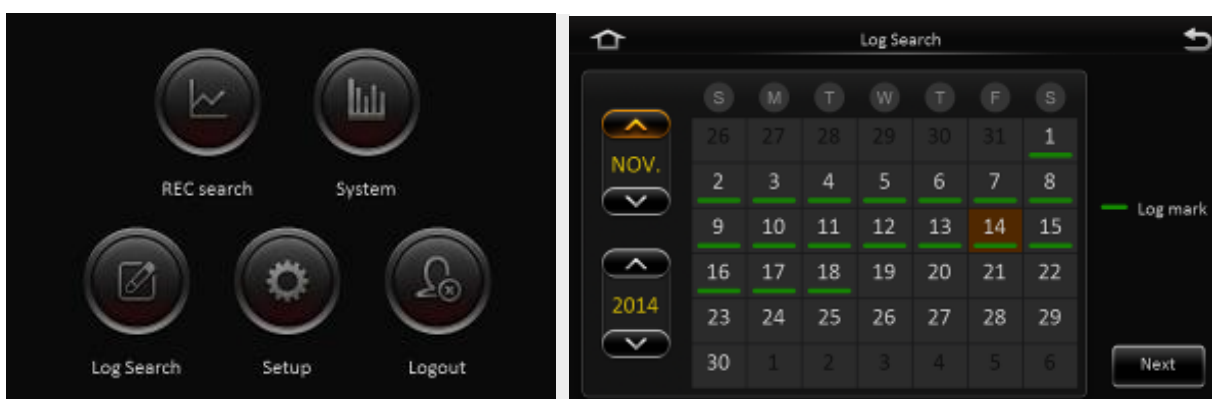

➤ Log Search interface instruction:

- **Calendar:** the date with log will be marked on the calendar with green color.
Remark: There is no color classification in the "log mark", and all are green.

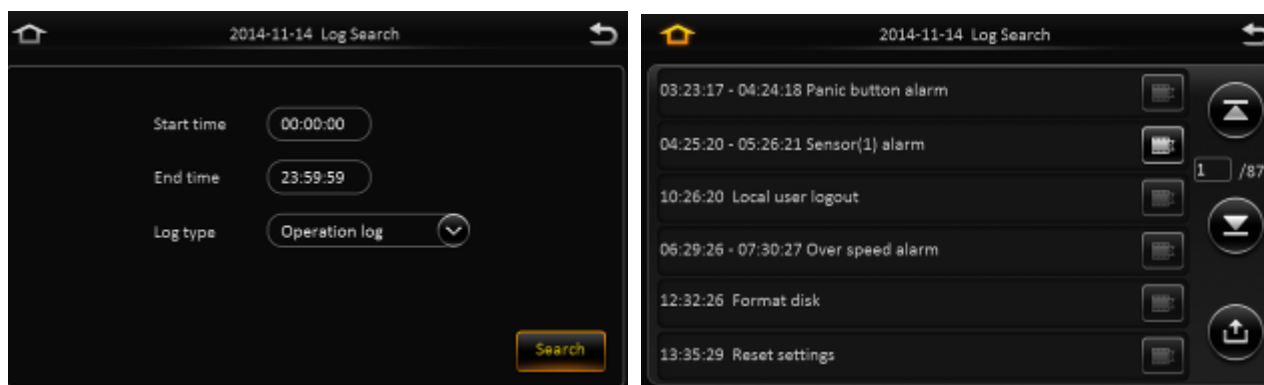

➤ Log search interface instruction:

- Start time: the start time for searching log files

- End time: the end time for searching log files
- Log types: classification of log search, including the operation log and alarm log and locking log
- Operation log search interface instruction
 - Log includes the following information:
 - ◆ Log time: the time when event is triggered
 - ◆ Log name: event content
 - Supports page up/page down and export all log files of the specified date.
 - Does not support link to video
- file. Log search
 - **Alarm type:** It includes all alarms, IO alarm , panic alarm and over speed alarm.
 - Log includes the following information:
 - ◆ Log time :the time when event is triggered
 - ◆ Log name: event content
 - Supports page up/page down and export all log files of the specified date.
 - Supports link to video file, click on  button to playback video files
- Lock log search
 - Log includes the following information:
 - ◆ Log time: the time of when event triggered.
 - ◆ Log name: event content

Log will be recorded according to channel number, each channel will have a lock log file.
 - Support page up and page down.
 - Can't export all log files of the specified date.
 - Can link to video file, click on  button to playback video files.
 - **Unlock:** Select log, and unlock it. Then the alarm log of lock will be cleared.

Remark:

When locking the video file, system will record alarm log and lock log. The locked video file can only be unlocked from alarm log.

3.4. SYSTEM STATUS

User can login the interface with no access restrictions.

- System- Version information



➤ System- Modules



➤ System-Server status



➤ System - Environment



➤ System-Storage:

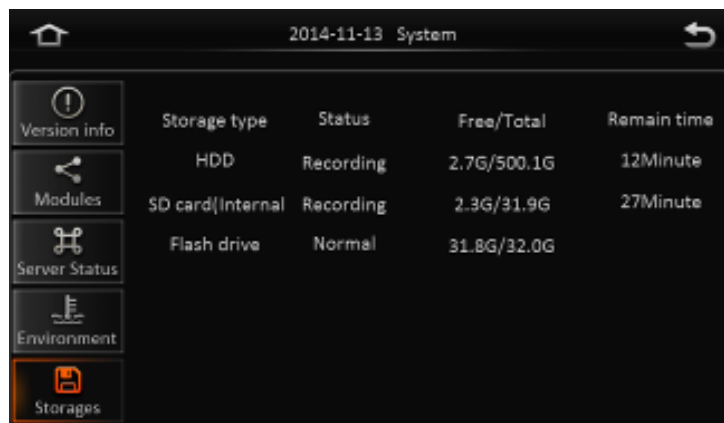

Storage type	Status	Free/Total	Remain time
HDD	Recording	2.7G/500.1G	12Minute
SD card Internal	Recording	2.9G/31.9G	27Minute
Flash drive	Normal	31.8G/32.0G	

3.5. BASIC SETUP

Click setup button and enter the following interfaces:

3.5.1. REGISTER INFORMATION (SETUP VEHICLE INFORMATION)

- Register information-Device info:

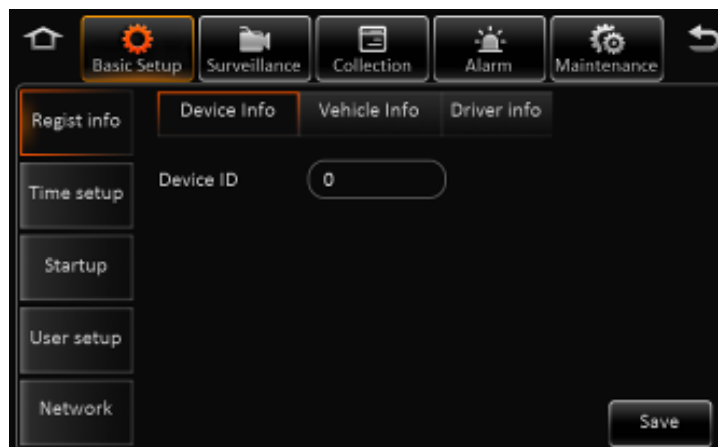

- **Device ID: Not used**

- Register information- Vehicle info



- **Vehicle Number:** When connected with PAD, the vehicle number is needed.
- **Vehicle plate:** Input manually.

- **Line number:** Input manually.
- Register information—Driver's information:



- **Driver number:** Input manually.
- **Driver name:** Input manually.

3.5.2. TIME SETUP



- Time setup-General
 - **Date format:** Setup the date format of device
 - **Time format:** 24 hours or 12 hours
 - **Time zone:** Range from -12th ~ +13th

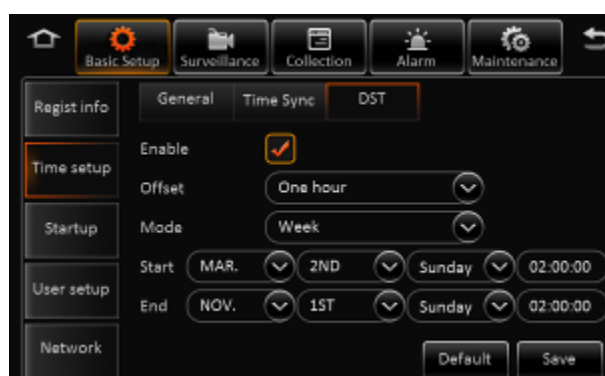
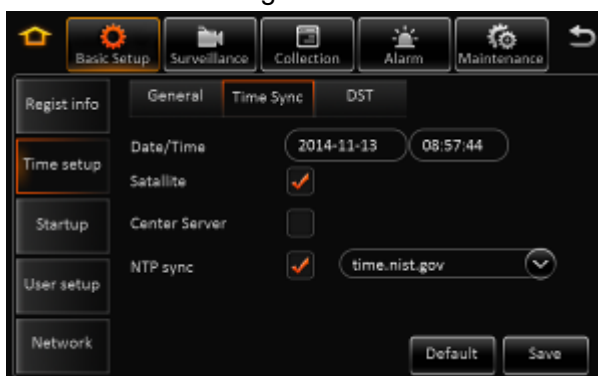

- Time-Time Sync
 - **Date/Time:** Device time, from 2000-01-01 to 2037-12-31

- Satellite: Synchronize time with GPS satellite. Once GPS signal is acquired, device will synchronize time
- Center Server: synchronize time with center server
- NTP server: synchronize time with NTP server

Remark:

- 1) Synchronize time according to time zone
- 2) Multi-mode can be selected for time synchronization.
- 3) Time setup-DST
 - Enable: Select to enable
 - Offset: After enabling DST, adjust the hour manually
 - Mode: Setup DST according to week or date
 - Start: Time to start DST
 - End: Time to end DST

3.5.3. START UP

- Startup-ON/OFF

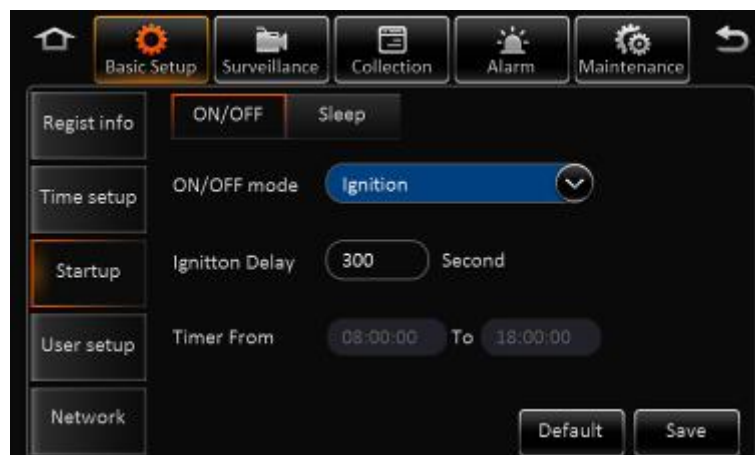

ON/OFF mode: 3 modes, including ignition, timer and ignition or timer.

Ignition: Input ignition delay time for shutdown delay function

Timer: When the start mode is Timer, please setup the start time and end time

Under this mode, MDVR's start up or shut down time will not respond to ignition input.

NOTE:

If using setup as Ignition or Timer Mode, Ignition ON or Timer start time triggers MDVR start up.

When Ignition off and Timer end time, MDVR will shut down.

- Start-Sleep



- **Sleep Mode:** Currently, there is only no consumption standby mode available.
- **Low Voltage Protection:** Enables the low voltage shutdown protection mode selection.
- **Low Battery Protection:** When consistently below the standard value, countdown to shutdown begins. 12V vehicle default is 9V, 24V vehicle is 21V.
Recovery boot voltage values: When the battery voltage is consistently greater than the standard value, it will automatically boot. As for a 12V vehicle, the default is 12.5V, while a 24V vehicle is 24.5V.
- **Low voltage reporting:** The low-voltage protection will be reported to the server when selected.

3.5.4. USER SETTING

In the basic settings, click user settings, enter the following interface, user can enter setting menu.

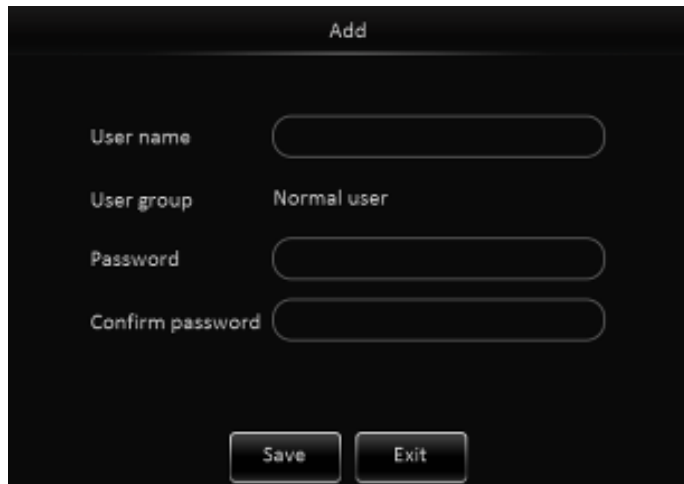

- **User name:** Admin and User are system defaults.
- **User Group:** It is divided into administrator and standard user.
- Supports delete user function. Select the user and click "Delete User" button. Please note, administrator cannot be deleted.
- Supports add user function. Click "Add User" button, then enter the following interface

**NOTE:**

- 1) Only administrators can add users.
- 2) 2 additional users can be added.
- 3) User name cannot be empty.

User name and password can be modified. Select a user, click the "Edit User" button, enter the

➤ following interface:

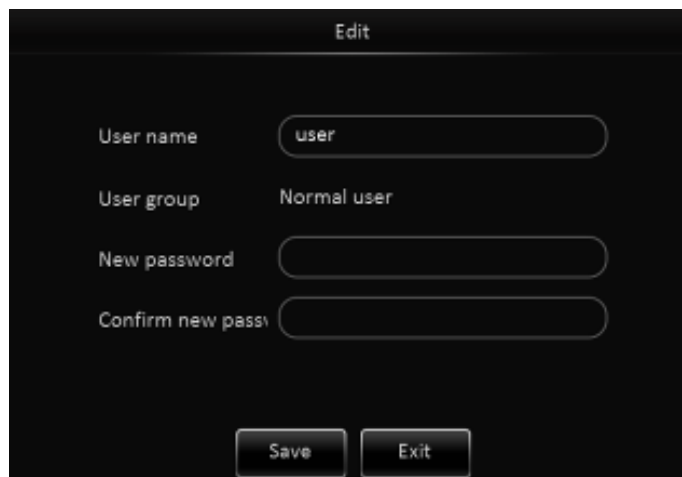

Modify the user name and password and press save. Administrator user name cannot be modified.

3.5.5. NETWORK SETTINGS

In the basic settings, click Network Settings, enter the following interface, user can set network parameters.

➤ Network Settings - wired network and port interface description

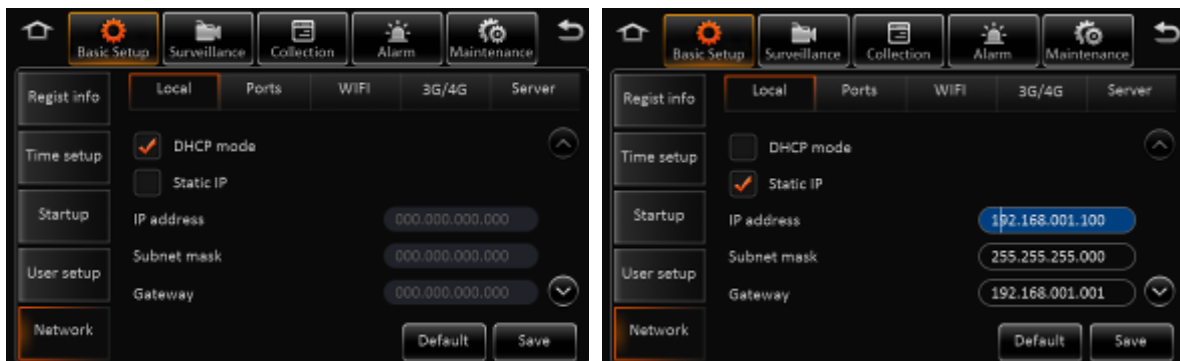

- DHCP mode: Obtain IP address from server. DNS can also be set to static or Dynamic
- **NOTE:** Static IP requires static DNS.

NOTE:

When switching to DHCP from Static, the dynamic IP is displayed. The last saved static IP will be displayed after switching back to Static.

➤ Network Settings - Port Interface Description:



- **WEB port No.:** The default is 80, will be used in IE to access this port.
- **Media Port No.:** The default is 81, the forwarding server will use this port.

➤ Net working settings- Instruction of wifi network:

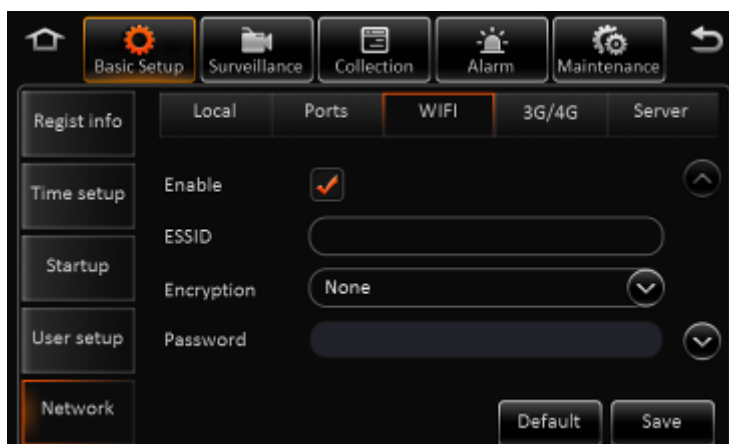

- **Enable :** Select to enable WIFI
- **ESSID:** Manually input the address of AP

- **Encryption:** NONE, WEP and WPA
- **Password:** Manually input
- **Static IP:** Select to use static IP, or MDVR will get dynamic IP

➤ Network-3G/4G network interface:

Dialing wireless network, user needs to choose the module type and setup dialing parameters



- **No Service.** When entering the dialing setup interface, MDVR discovers the wireless module type automatically. No Service indicates no module or no signal.
- **Network type:** The default is Mix, 3G and 3G/4G is optional.
- **Dialing parameter:** Access point, user name, password, data service number, and enter SIM parameters provided by the manufacturer. The default is empty, the program comes with empty arguments by dialing.
- **Certification:** Supports PAP or CHAP.

NOTE:

When SIM exists with normal 3G/4G signal, it will dial automatically.

➤ Network- server

Server's IP address and port are needed for device registering to server. Select CMS if there is wire or WIFI. Set up central IP and port, Select 4G CMS when dialing wireless network.



By default, there is only one server, but user can add additional servers. Server 1 can't be deleted.

4. VIDEO SURVEILLANCE

4.1. REAL-TIME SURVEILLANCE

Surveillance-->Real-time Surveillance

➤ Real-time Setting Interface:



- **Audio:** Enables audio on monitor view.
- **Image Setting:** Set the live-view parameters, including brightness, contrast, etc.
- **Splash Screen:** Set the live-view screen; single, dual or quad screen
- **Channel:** Set the channel when live-view

➤ Auto Polling Setting Interface:

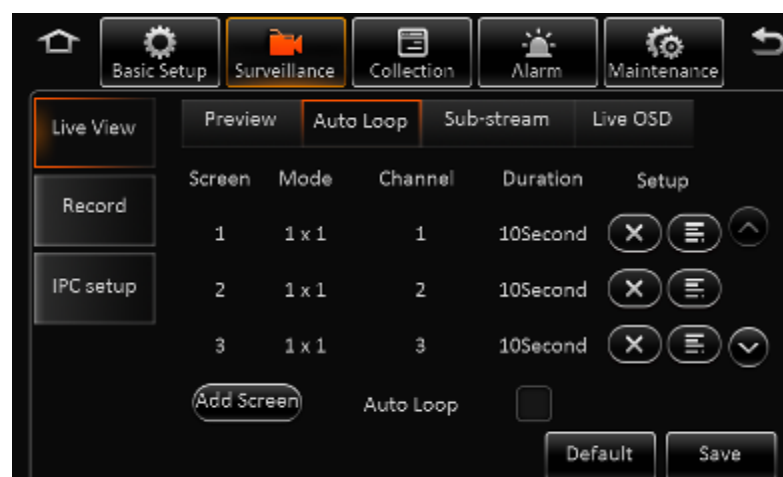

- **Screen:** 32 screens can be added..
- **Mode:** 1x1, 2x2, 3x3 optional.
- **Channel:** Included channel number.
- **Residence time:** Residence time for each screen.
- **Edit:** Delete or Edit.
- **Add screen:** Add polling screen
- **Auto polling:** Enable the auto pulling

➤ Sub-stream Setting Interface:

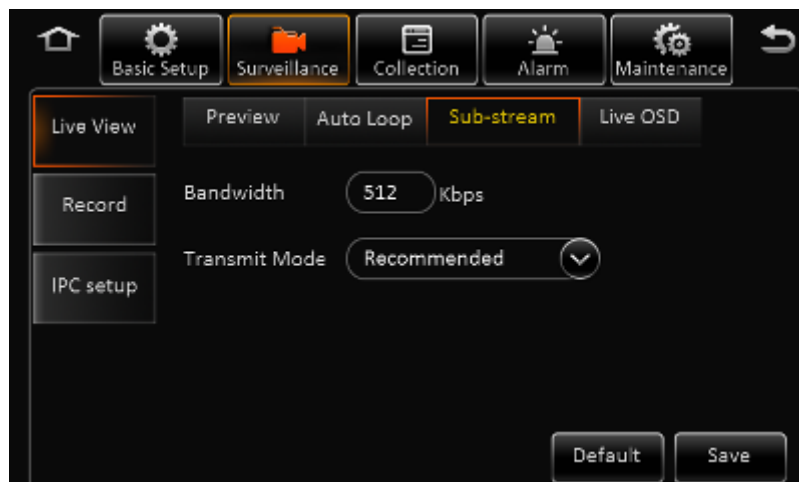

- **Total bandwidth:** Set the bandwidth, default is 500Kbps maximum 5M
- **Transmit mode:** Default is the recommended (smooth + clear) mode, divided into five levels.

➤ Live-view OSD Setting Interface:

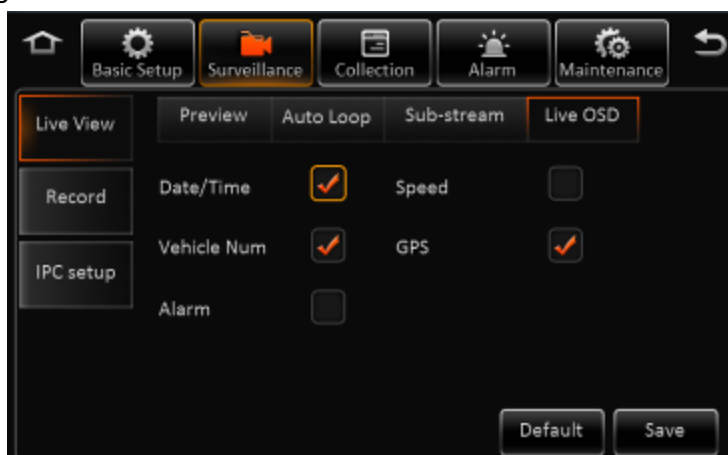

Display the information on screen, default is only the time, and the position cannot be set.

4.2. RECORD

Surveillance-->Record

➤ Record Setting Interface:

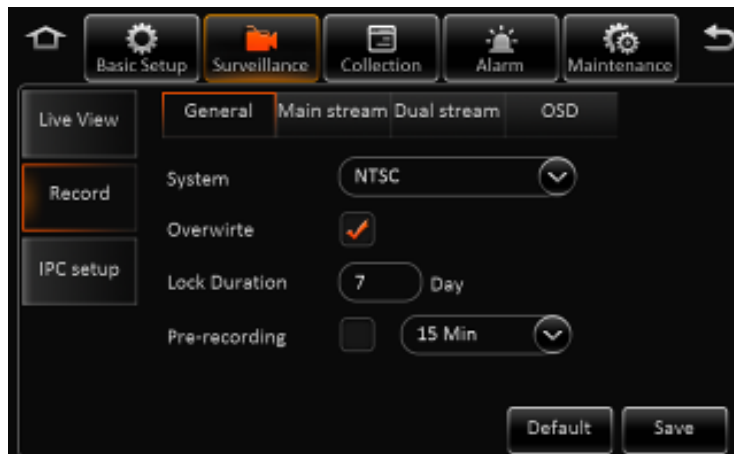

- **Video type:** Default is NTSC, PAL is optional

- **Overwrite:** Enable the HDD to be overwritten when it is full
- **Lock file retention:** Protect the record file from deletion, default is 7 days
- **Pre-recording:** Pre-record before alarm trigger. Default is 15min, 0-60min optional.

➤ Main Stream Setting Interface:

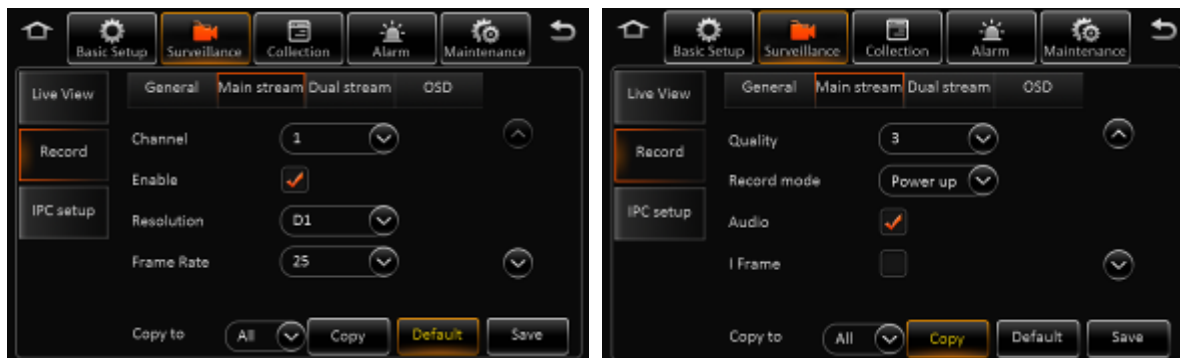

- **Channel:** 1-8 channels can be chosen and set the record parameters
- **Enable:** Enable the main stream record function
- **Resolution:** The analog channel supports D1/HD1/CIF/WD1/WHD1/WCIF while the digital one supports 720/1080p
- **Frame Rate:** Frame Rate of the record
- **Picture Quality:** Picture Quality of the record
- **Record Type:** Ignition, Time, Event optional. Each channel can be set separately. The sub-stream and mirror record are the same
- **Audio:** Enable the audio. Note: Audio cannot be recorded separately

➤ Record file only without alarm: Enable to let the frame rate invalid, record file is I frame only



- **Storage:** The storage type for second stream, internal SD, or external SD
- **Record mode:** Mirror record, alarm back-up, and sub stream
 - **Mirror record:** Channel is selectable. Video resolution and frame rate are the same with main stream.
 - **Alarm backup:** Channel is selectable. The parameters are the same with main stream
 - **Sub-stream:** Channel is selectable. Recording parameters are configurable
- **Mirror channel:** It is selectable according record mode

➤ Dual stream-Sub-stream



Parameters includes channel number, enable or not, audio, resolution, frame rate and image quality
 Can't record I frame only, record parameters is completely separated from main stream.

Remark:

Main stream +sub-stream total resource can't over 12M

➤ Record-OSD

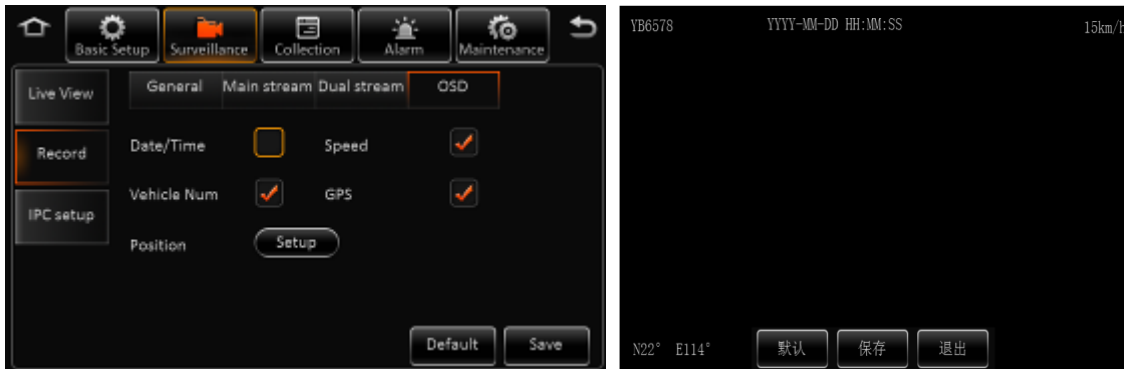

Embedded key information to video file for easily check when playback.

4.3. IPC SETUP

➤ IPC setup:



- **Channel:** 1-6 are default for analog cameras. 7-8 channels are for IP cameras
- **Enable IPC:** Enable to operate
- **IP and port:** Display channel number and port
- **Setup:** Search and edit IP camera recording parameters
- **Fast setup:** Search all the IP cameras in LAN network, and auto assign IP address to IP camera.
-

4.4. DATA COLLECTION

GENERAL

➤ General- IO sensor



- **Sensor number:** 1~8 optional.
- **Sensor name:** IO sensor name.
- **OSD name:** The information embedded to video image.
- **Copy:** Copy the configuration and use it for other sensors.

➤ General- Serial port:

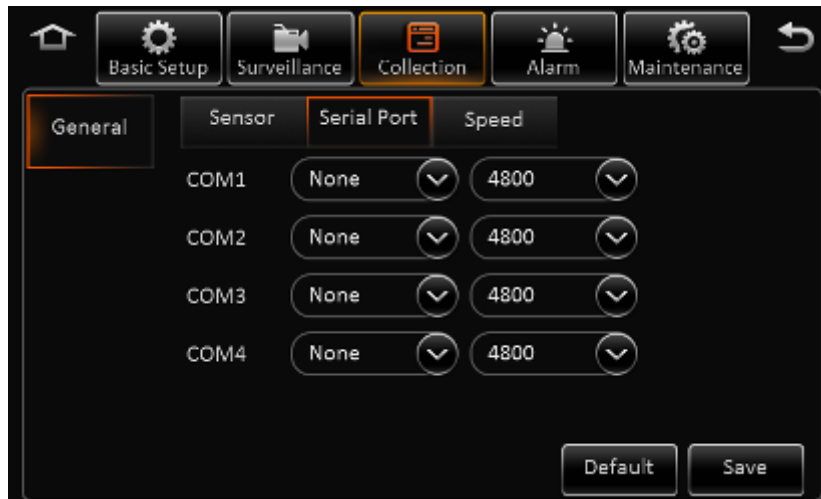

➤ General- speed

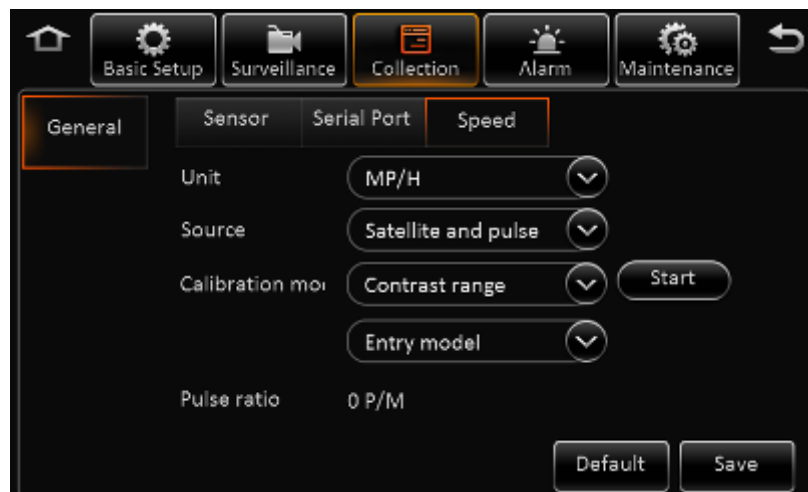

- **Unit:** KM/H and MPH selectable.
- **Source:** GPS, pulse or both optional.
- **Calibration mode:** No need to calibrate if setup as satellite mode.

4.5. ALARM

GENERAL

- General --Speed alarm



- **Name:** The current name is Over speed
- **Enable:** Enable or disable, tick to enable
- **Alarm type:** 3 levels
- **Trigger:** Low or high voltage to trigger alarm
- **Linkage:** When alarm triggered, link to alarm output, full screen live video, report to server

- General- Panic alarm :



- **Name:** The current name is panic.
- **Enable:** Enable or disable
- **Alarm type:** 3 levels
- **Trigger:** Low or high voltage to trigger alarm.
- **Linkage:** When alarm is triggered, link to alarm output, full screen live video, report to server

- General – IO alarm interface:



- **Name:** From Sensor1 to Sensor8
- **Enable:** Enable this sensor or not, tick to enable
- **Alarm type:** 3 levels
- **Trigger:** Low or high voltage trigger alarm
- **Linkage:** Link to sensor out, report alarm or full screen

➤ IO sensor- Alarm linkage interface

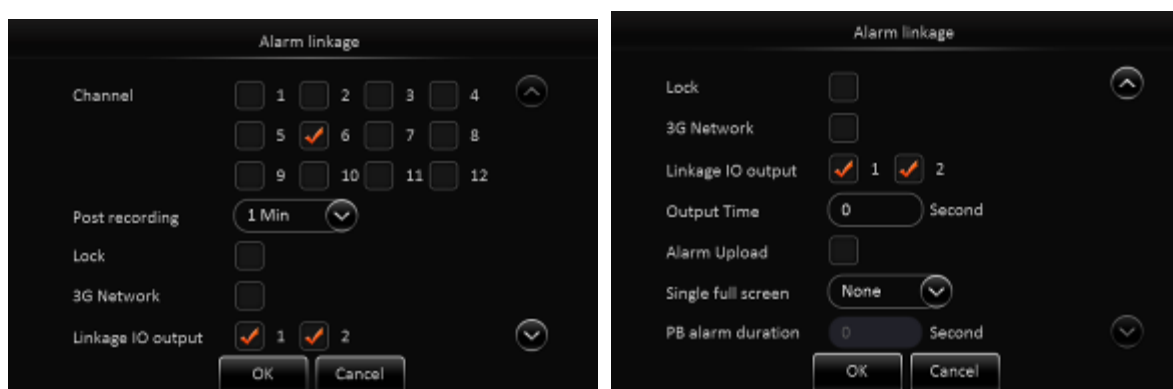

- **CH:** Associate recording, optional
- **Post-recording:** When the alarm is canceled, the time continues to record
- **Lock:** Only for alarm video
- **3G Network:** When the alarm is triggered, activates the 4G module or not
- **Linkage output:** When alarm is triggered, associate with which sensor output
- **Output time:** When the alarm is canceled, duration of the sensor output
- **Upload CMS:** Upload the alarm info to center server or not
- **Full screen:** When the alarm is triggered, associate with a single channel to full screen or not
- **Alarm duration time:** When alarm is canceled, during this time if this alarm is triggered again, It won't be acknowledged

4.6. MAINTENANCE

After login, click setup>Maintenance, and then enter into the page as follow.

4.6.1. CONFIGURATION

In the configuration page, user can export and import the configuration file.

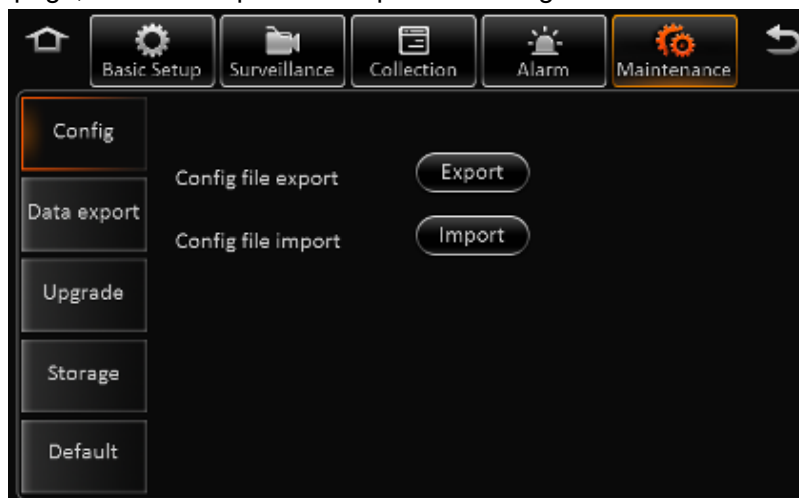

- Insert the USB drive, and then click “EXPORT”, it will export the configuration file to the root folder of USB drive, the file name is MDVFCFG.CFG
Import all the parameters
- Insert the USB drive that with configuration file into MDVR, and login this page and click the “IMPORT” to import the parameters, and it will display the notice when import success.
- NOTE: it won't import the register info, network info and speed adaption info.

4.6.2. DATA EXPORT

In the Data export page, you can export the appointed file in any time, such as black box data, log file.

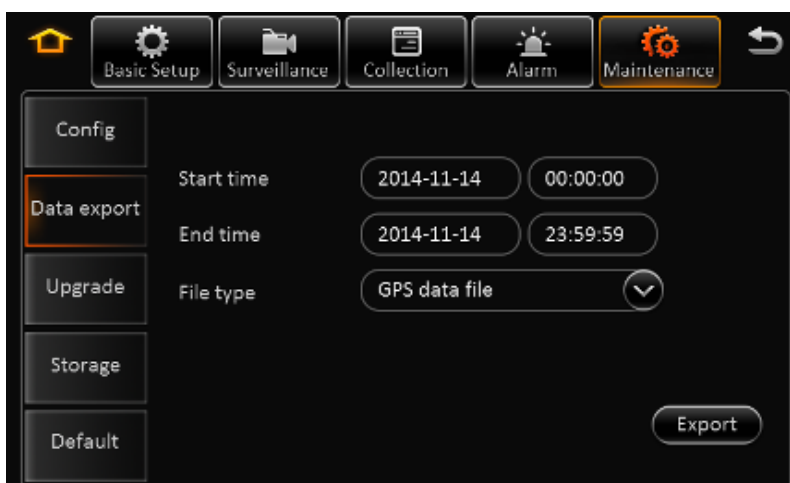

4.6.3. UPGRADE

In the page of upgrade, you can upgrade the firmware, MCU for MDVR

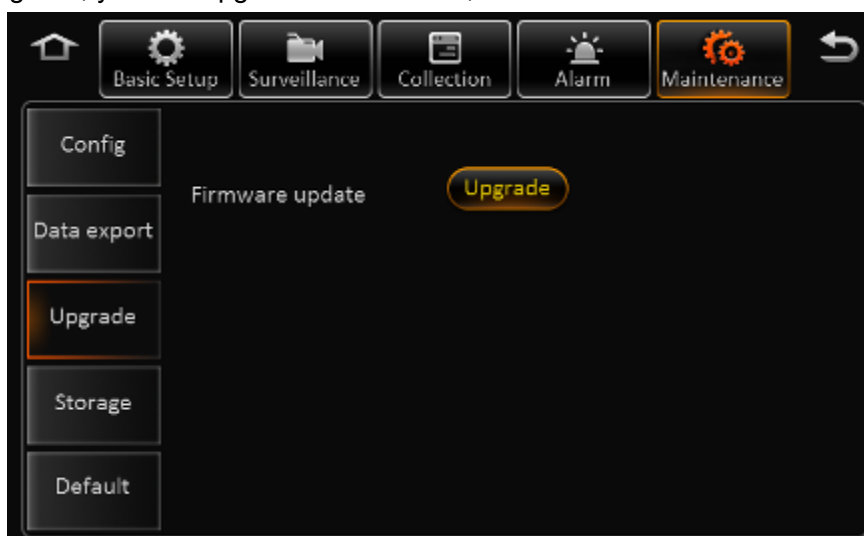

NOTE:

- 1) Ensure uninterrupted power during upgrade process.
- 2) Copy the upgrade file into the folder "upgrade", which is at the root directory of the USB drive
- 3) It supports upgrade firmware, MCU, and MCU for Monitor.
- 4) Firmware and MCU will package in one file, and it will upgrade MCU first, and then firmware.
- 5) Please don't put many files in the same folder when it is upgrading, otherwise, it will upgrade one randomly.

4.6.4. STORAGE

In this page, user can format all the storage.



➤ Storage type:

HDD, SD card (Internal), SD card (External), USB drive

➤ **Free/Total**

Not exist: Didn't find the HDD (not installed or defective)

Unformatted: Means the HDD has been detected, but unformatted.(New

HDD) Capacity info: Indicates total capacity of HDD

➤ **Format:**

Click the Format button to start format, if format successful, recording will start immediately

4.6.5. DEFAULT

In this page, you can click the default button to reset the parameters to factory settings.

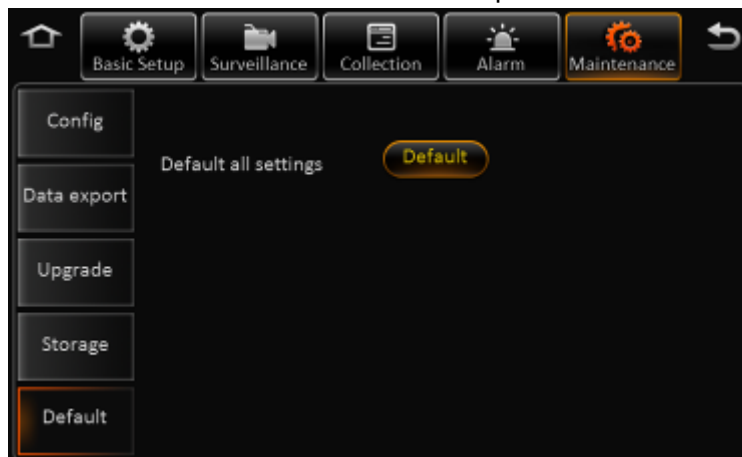

Remark:

Language, MAC address, register info, CMS server info, speed adaption parameter will not change during default settings.

MOBILE DVR INSTALL GUIDE



MOUNTING DVR

- Mount lock box so that front door is unobstructed, and top can be removed.
- Mount DVR into lock box, using existing holes in lock box base allowing for front door clearance (Use included 1/2" fasteners)

CABLE CONNECTIONS

1. Connect Power cable to DVR (1A. Note correct fuse for system voltage)

DVR WIRING DIAGRAM - POWER

RED WIRE – CONSTANT 12V (FUSE 7.5 for 24v - 15 for 12v systems)

YELLOW WIRE – IGNITION SWITCHED

BLACK WIRE – GROUND

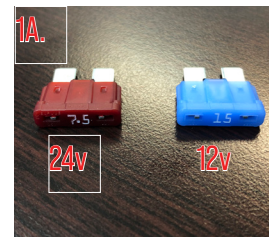

2. Connect monitor to monitor cable to DVR port "Panel"



3. Connect the monitor cable from the DVR to the in-cab monitor cable. (Ensure the Monitor is mounted within clear sight of driver/operator).



Have any questions or need additional information? | Call us today at 1300 217 623

A1 Roadlines | www.a1roadlines.com.au | sales@a1roadlines.com.au

4. Routing of cameras and GPS/4G antenna cables *Optional when equipped*.

- Run all cables ensuring they are secured and there are no pinch points.
- Mount Cameras to meet build specifications

5. 4G Antenna – When equipped, mount on any window with clear view of sky
(Do not mount to sliding window)

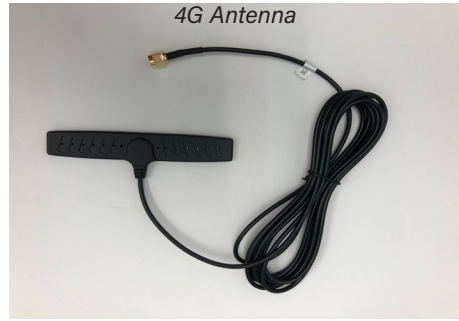

6. Mount GPS Antenna on dash with silver label down and with clear view of the sky.



7. Connect 4g antenna cable to rear of DVR (Ensure you connect to the below port)



8. Connect GPS antenna cable to rear of DVR



Note: *The following steps are only applicable for DVRs that are:*

- A. Mounted in a lock box
- B. Utilizing a radar board
- C. Utilizing side view cameras

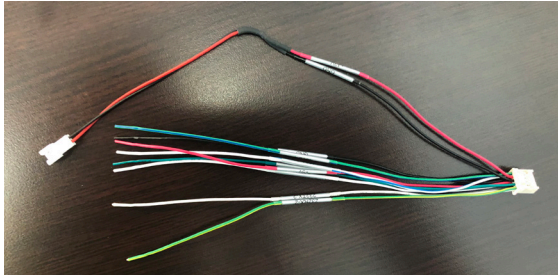

Serial Harness for Lockbox Fan

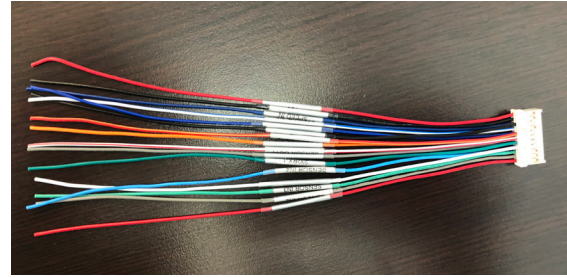

Serial Harness for Additional Equipment

9. Connect serial adapter with lockbox fan attachment to serial port on rear of DVR



10. Connect serial adapter with lockbox fan to fan harness in lockbox

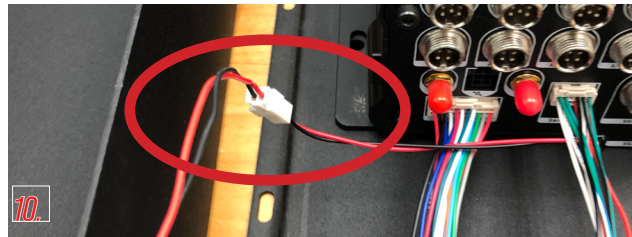
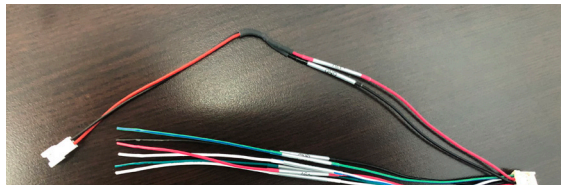

NOTE:

When reinstalling lock box top, ensure wires are clear and secured to prevent pinching between lock box top and base.

R8 MOBILE DVR STATUS LIGHTS



Normal operation - Blue PWR and Green REC



Normal operation with A1 Roadlines Server connection - Blue PWR, Green REC and blinking Green NET light



An Orange **ERR** and Red **ALM** light may indicate a missing or damaged SD card, SSD or a disconnected or damaged camera.